

FOD8001

High Noise Immunity, 3.3V/5V Logic Gate Optocoupler

Features

- High Noise Immunity characterized by Common Mode Rejection (CMR) and Power Supply Rejection (PSR) specifications
 - 20kV/μs Minimum Static CMR @ $V_{cm} = 1000V$
 - 25kV/μs Typical Dynamic CMR @ $V_{cm} = 1500V$, 20Mbaud Rate
 - PSR in excess of 10% of the supply voltages across full operating bandwidth
- High Speed:
 - 25Mbit/sec Date Rate (NRZ)
 - 40ns max. Propagation Delay
 - 6ns max. Pulse Width Distortion
 - 20ns max. Propagation Delay Skew
- 3.3V and 5V CMOS Compatibility
- Extended industrial temperature range, -40°C to 105°C temperature range
- Safety and regulatory pending approvals:
 - UL1577, 3750 VACRMS for 1 min.
 - IEC60747-5-2

Applications

- Industrial fieldbus communications
 - Profibus, DeviceNet, CAN, RS485
- Programmable Logic Control
- Isolated Data Acquisition System

Description

The FOD8001 is a 3.3V/5V high-speed logic gate Optocoupler, which supports isolated communications allowing digital signals to communicate between systems without conducting ground loops or hazardous voltages. It utilizes Fairchild's patented coplanar packaging technology, Optoplanar®, and optimized IC design to achieve high noise immunity, characterized by high common mode rejection and power supply rejection specifications.

This high-speed logic gate optocoupler, packaged in a compact 8-pin small outline package, consists of a high-speed AlGaAs LED driven by a CMOS buffer IC coupled to a CMOS detector IC. The detector IC comprises an integrated photodiode, a high-speed transimpedance amplifier and a voltage comparator with an output driver. The CMOS technology coupled to the high efficiency of the LED achieves low power consumption as well as very high speed (40ns propagation delay, 6ns pulse width distortion).

Related Resources

- www.fairchildsemi.com/products/opto/
- www.fairchildsemi.com/pf/FO/FOD0721.html
- www.fairchildsemi.com/pf/FO/FOD0720.html
- www.fairchildsemi.com/pf/FO/FOD0710.html

Functional Schematic

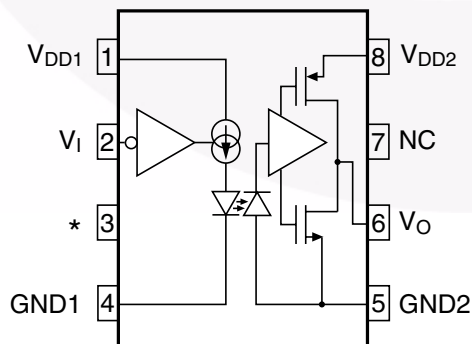

*: Pin 3 must be left unconnected

Truth Table

V_i	LED	V_o
H	OFF	H
L	ON	L

Pin Definitions

Pin Number	Pin Name	Pin Function Description
1	V _{DD1}	Input Supply Voltage
2	V _I	Input Data
3		LED Anode – Must be left unconnected
4	GND1	Input Ground
5	GND2	Output Ground
6	V _O	Output Data
7	NC	Not Connected
8	V _{DD2}	Output Supply Voltage

Absolute Maximum Ratings (T_A = 25°C Unless otherwise specified.)

Stresses exceeding the absolute maximum ratings may damage the device. The device may not function or be operable above the recommended operating conditions and stressing the parts to these levels is not recommended. In addition, extended exposure to stresses above the recommended operating conditions may affect device reliability. The absolute maximum ratings are stress ratings only.

Symbol	Parameter	Value	Units
T _{STG}	Storage Temperature	-55 to +125	°C
T _{OPR}	Operating Temperature	-40 to +105	°C
T _{SOL}	Lead Solder Temperature (Refer to Reflow Temperature Profile)	260 for 10 sec	°C
V _{DD1} , V _{DD2}	Supply Voltage	0 to 6.0	V
V _I	Input Voltage	-0.5 to V _{DD1} + 0.5	V
I _I	Input DC Current	-10 to +10	μA
V _O	Output Voltage	-0.5 to V _{DD2} + 0.5	V
I _O	Average Output Current	10	mA
PD _I	Input Power Dissipation ⁽¹⁾⁽³⁾	90	mW
PD _O	Total Power Dissipation ⁽²⁾⁽³⁾	70	mW

Recommended Operating Conditions

The Recommended Operating Conditions table defines the conditions for actual device operation. Recommended operating conditions are specified to ensure optimal performance to the datasheet specifications. Fairchild does not recommend exceeding them or designing to absolute maximum ratings.

Symbol	Parameter	Min.	Max.	Unit
T _A	Ambient Operating Temperature	-40	+105	°C
V _{DD1} , V _{DD2}	Supply Voltages (3.3V Operation) ⁽⁴⁾	3.0	3.6	V
	Supply Voltages (5.0V Operation) ⁽⁴⁾	4.5	5.5	
V _{IH}	Logic High Input Voltage	2.0	V _{DD}	V
V _{IL}	Logic Low Input Voltage	0	0.8	V
t _r , t _f	Input Signal Rise and Fall Time		1.0	ms

Notes:

- Derate linearly from 25°C at a rate of tbd W/°C
- Derate linearly from 25°C at a rate of tbd mW/°C.
- Functional operation under these conditions is not implied. Permanent damage may occur if the device is subjected to conditions outside these ratings.
- 0.1μF bypass capacitor must be connected between Pin 1 and 4, and 5 and 8.

Isolation Characteristics (Apply over all recommended conditions, typical value is measured at $T_A = 25^\circ\text{C}$)

Symbol	Characteristics	Test Conditions	Min.	Typ.*	Max.	Unit
V_{ISO}	Input-Output Isolation Voltage	$f = 60\text{Hz}$, $t = 1.0\text{ min}$, $I_{I-O} \leq 10\mu\text{A}^{(5)(6)}$	3750	—	—	$V_{AC_{RMS}}$
R_{ISO}	Isolation Resistance	$V_{I-O} = 500\text{V}^{(5)}$	10^{11}	—	—	Ω
C_{ISO}	Isolation Capacitance	$V_{I-O} = 0\text{V}$, $f = 1.0\text{MHz}^{(5)}$	—	0.2	—	pF

Notes:

- Device is considered a two terminal device: Pins 1, 2, 3 and 4 are shorted together and Pins 5, 6, 7 and 8 are shorted together.
- $3,750 V_{AC_{RMS}}$ for 1 minute duration is equivalent to $4,500 V_{AC_{RMS}}$ for 1 second duration.

Electrical Characteristics (Apply over all recommended conditions, typical value is measured at $V_{DD1} = V_{DD2} = +3.3\text{V}$, $V_{DD1} = +3.3\text{V}$ and $V_{DD2} = +5.0\text{V}$, $V_{DD1} = +5.0\text{V}$ and $V_{DD2} = +3.3\text{V}$, $V_{DD1} = V_{DD2} = +5.0\text{V}$, $T_A = 25^\circ\text{C}$)

Symbol	Parameter	Conditions	Min.	Typ.	Max.	Units
INPUT CHARACTERISTICS						
I_{DD1L}	Logic Low Input Supply Current	$V_I = 0\text{V}$		6.2	10.0	mA
I_{DD1H}	Logic High Input Supply Current	$V_I = V_{DD1}$		0.8	3.0	mA
I_{IA}, I_{IB}	Input Current		-10		+10	μA
OUTPUT CHARACTERISTICS						
I_{DD2L}	Logic Low Output Supply Current	$V_I = 0\text{V}$		4.5	9.0	mA
I_{DD2H}	Logic High Output Supply Current	$V_I = V_{DD1}$		4.5	9.0	mA
V_{OH}	Logic High Output Voltage	$I_O = -20\mu\text{A}$, $V_I = V_{IH}$, $V_{DD2} = +3.3\text{V}$	2.9	3.3		V
		$I_O = -4\text{mA}$, $V_I = V_{IH}$, $V_{DD2} = +3.3\text{V}$	1.9	2.9		
		$I_O = -20\mu\text{A}$, $V_I = V_{IH}$, $V_{DD2} = +5.0\text{V}$	4.4	5.0		
		$I_O = -4\text{mA}$, $V_I = V_{IH}$, $V_{DD2} = +5.0\text{V}$	4.0	4.8		
VOL	Logic Low Output Voltage	$I_O = 20\mu\text{A}$, $V_I = V_{IL}$		0	0.1	V
		$I_O = 4\text{mA}$, $V_I = V_{IL}$		0.3	1.0	

Switching Characteristics (Apply over all recommended conditions, typical value is measured at $V_{DD1} = V_{DD2} = +3.3V$, $V_{DD1} = +3.3V$ and $V_{DD2} = +5.0V$, $V_{DD1} = +5.0V$ and $V_{DD2} = +3.3V$, $V_{DD1} = V_{DD2} = +5.0V$, $T_A = 25^\circ C$)

Symbol	Parameter	Test Conditions	Min.	Typ.	Max.	Unit
t_{PHL}	Propagation Delay Time to Logic Low Output	$C_L = 15pF$		25	40	ns
t_{PLH}	Propagation Delay Time to Logic High Output	$C_L = 15pF$		25	40	ns
PWD	Pulse Width Distortion, $ t_{PHL} - t_{PLH} $	PWD = 40ns, $C_L = 15pF$		2	6	ns
	Data Rate				25	Mb/s
t_{PSK}	Propagation Delay Skew	$C_L = 15pF^{(7)}$			20	ns
t_R	Output Rise Time (10%–90%)			6.5		ns
t_F	Output Fall Time (90%–10%)			6.5		ns
$ICM_{H }$	Common Mode Transient Immunity at Output High	$V_I = V_{DD1}$, $V_O > 0.8 V_{DD1}$, $V_{CM} = 1000V^{(8)}$	20	40		kV/ μs
$ICM_{L }$	Common Mode Transient Immunity at Output Low	$V_I = 0V$, $V_O < 0.8V$, $V_{CM} = 1000V^{(8)}$	20	40		kV/ μs
C_{PDI}	Input Dynamic Power Dissipation Capacitance ⁽⁹⁾			30		pF
C_{PDO}	Output Dynamic Power Dissipation Capacitance ⁽⁹⁾			3		pF

Notes:

- t_{PSK} is equal to the magnitude of the worst case difference in t_{PHL} and/or t_{PLH} that will be seen between units at any given temperature within the recommended operating conditions.
- Common mode transient immunity at output high is the maximum tolerable positive dV_{cm}/dt on the leading edge of the common mode impulse signal, V_{cm} , to assure that the output will remain high. Common mode transient immunity at output low is the maximum tolerable negative dV_{cm}/dt on the trailing edge of the common pulse signal, V_{cm} , to assure that the output will remain low.
- Unloaded dynamic power dissipation is calculated as follows:
 $C_{PD} \times V_{DD} \times f + I_{DD} + V_{PD}$ where f is switched time in MHz.

Typical Performance Curves

Figure 1. Typical Output Voltage vs. Input Voltage

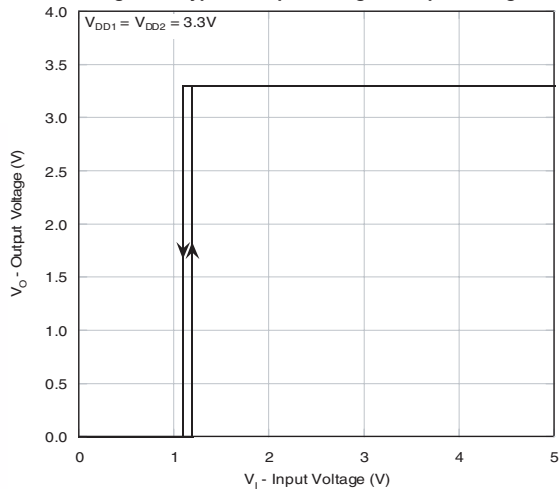

Figure 2. Input Voltage Switching Threshold vs. Input Supply Voltage

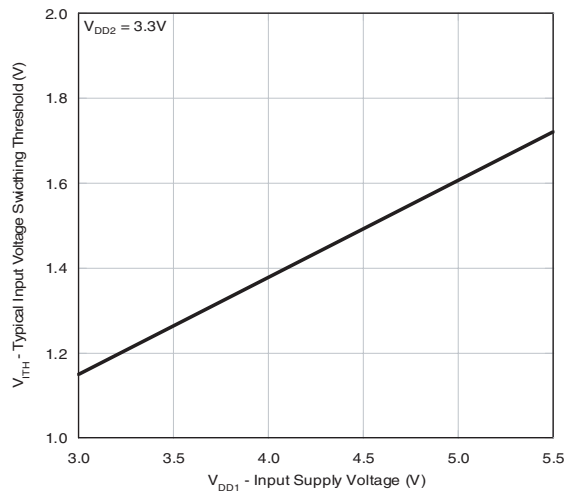

Figure 3. Propagation Delay vs. Ambient Temperature

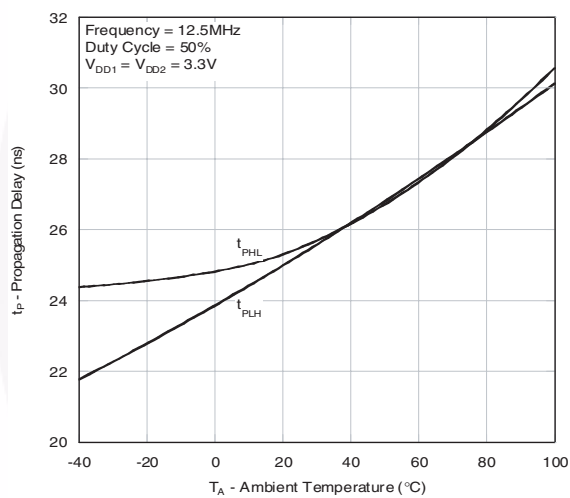

Figure 4. Pulse Width Distortion vs. Ambient Temperature

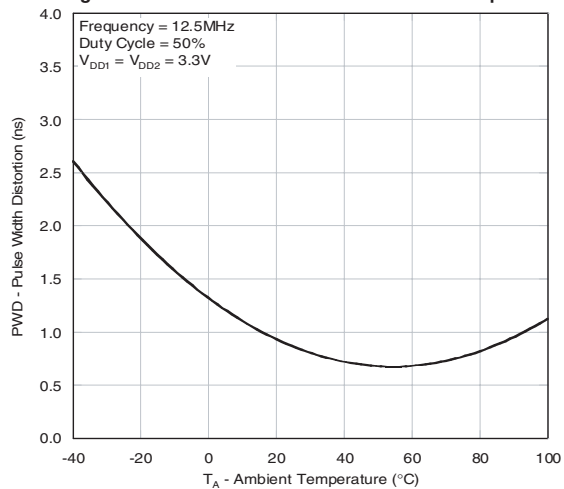

Figure 5. Typical Rise Time vs. Ambient Temperature

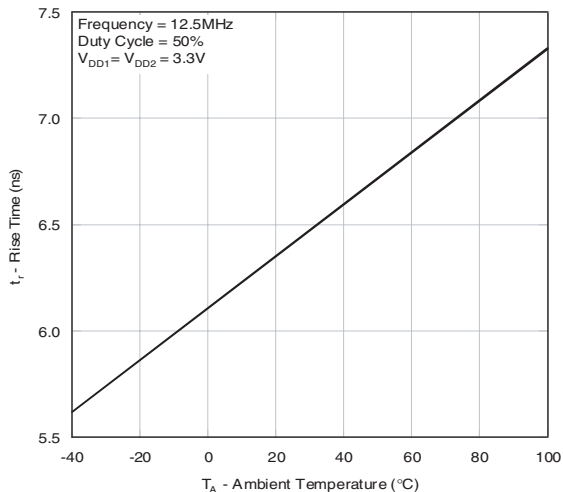
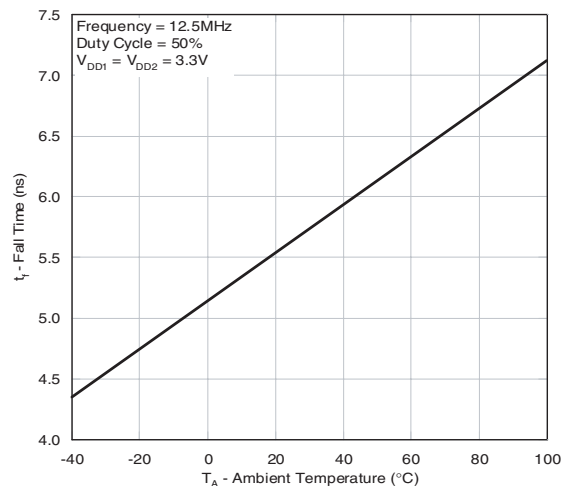

Figure 6. Typical Fall Time vs. Ambient Temperature



Typical Performance Curves (Continued)

Figure 7. Typical Propagation Delay vs. Output Load Capacitance

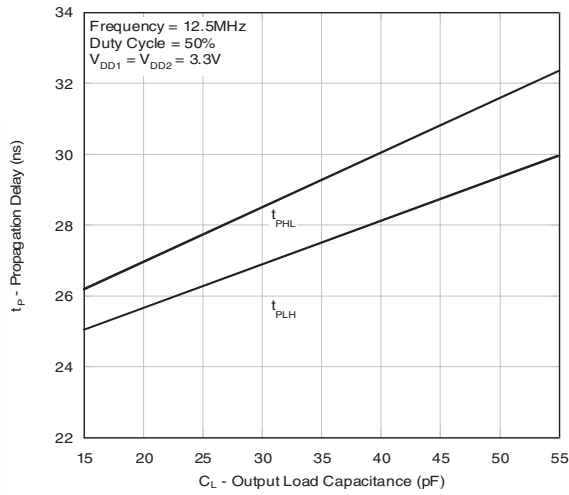

Figure 8. Typical Width Distortion vs. Output Load Capacitance

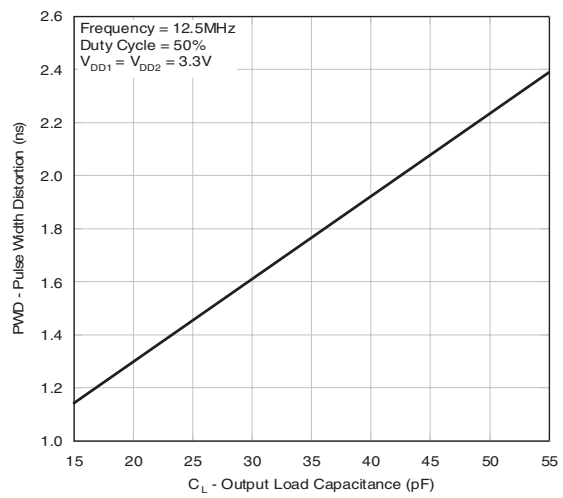

Figure 9. Typical Rise Time vs. Output Load Capacitance

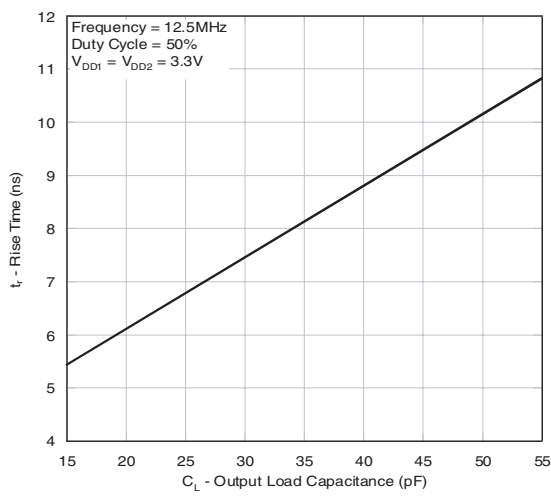

Figure 10. Typical Fall Time vs. Output Load Capacitance

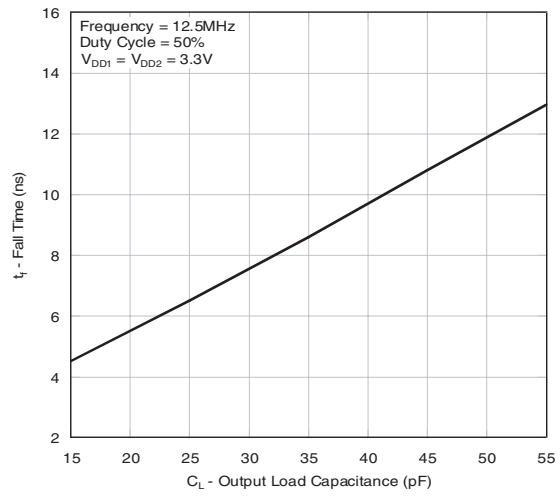

Figure 11. Input Supply Current vs. Frequency

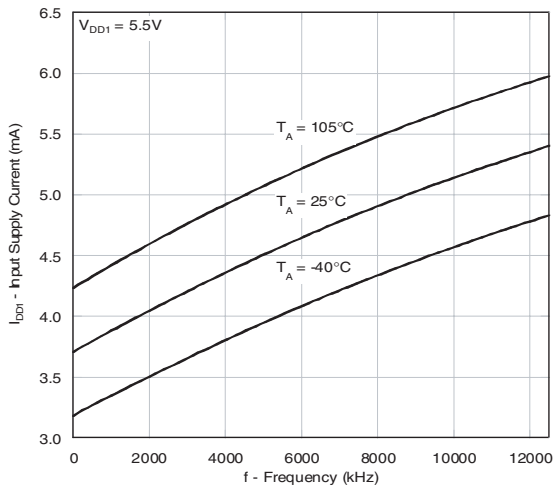
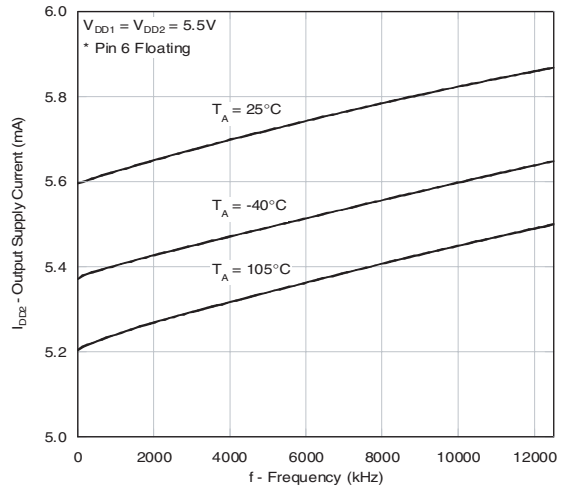

Figure 12. Output Supply Current vs. Frequency



Test Circuits

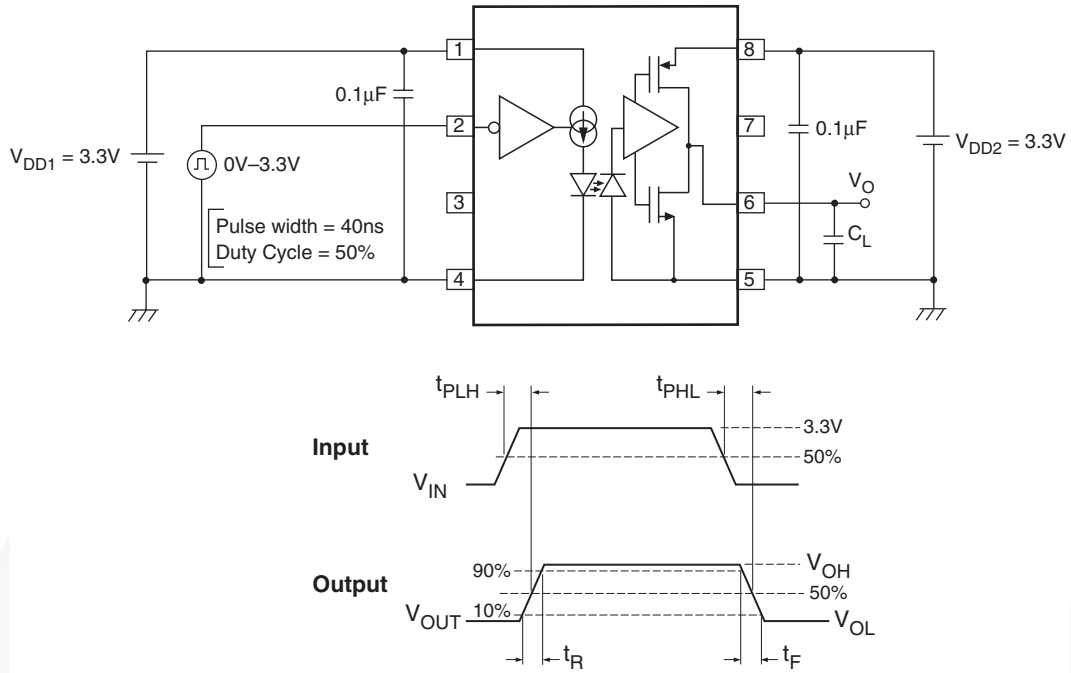

Figure 13. Test Circuit for Propagation Delay Time and Rise Time, Fall Time

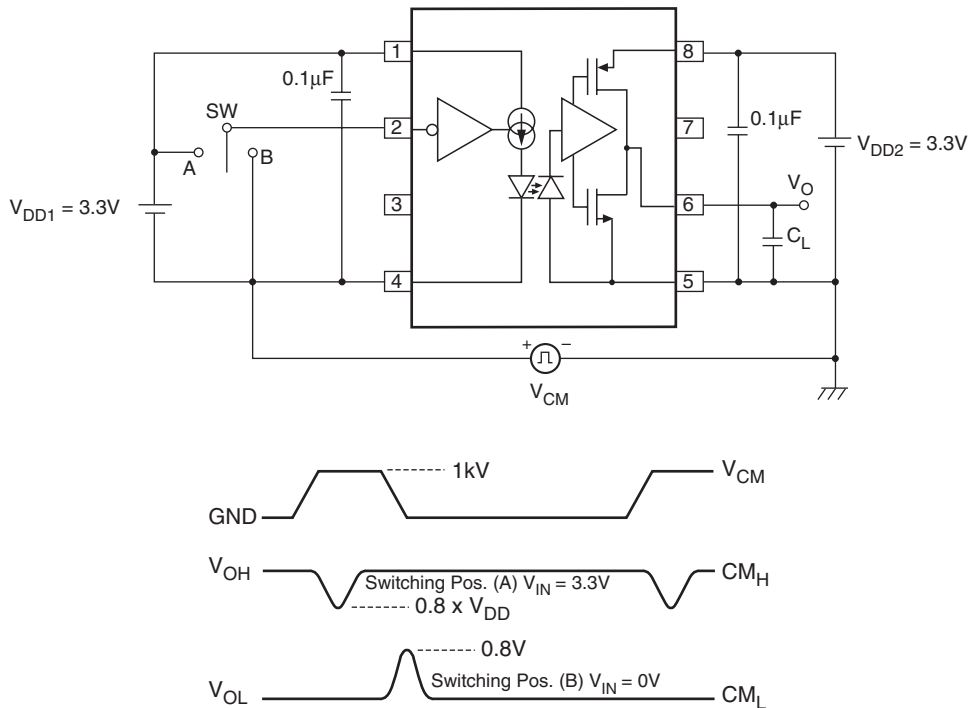

Figure 14. Test Circuit for Instantaneous Common Mode Rejection Voltage

Application Information

Noise is defined as any unwanted signal that degrades or interferes with the operation of a system or circuit. Input-output noise rejection is a key characteristic of an optocoupler, and the performance specification for this noise rejection is called, “Common Mode Transient Immunity or Common Mode Rejection, CMR”. The CMR test configuration is presented in high speed optocoupler datasheets, which tests the optocoupler to a specified rate of interfering signal (dv/dt), at a specified peak voltage (V_{cm}).

This defined noise signal is applied to the test device while the coupler is a stable logic high or logic low state. This test procedure evaluates the interface device in a constant or static logic state. This type of CMR can be referred to as “**Static CMR**”. Fairchild’s high speed optocouplers, which use an optically transparent, electrically conductive shield, and offer active totem pole logic output have static CMR in excess of 50KV/us at peak amplitudes of 1.5kV to 2.0kV.

Dynamic Common Mode Rejection

The noise susceptibility of an interface while it is actively transferring data is a common requirement in serial data communication. However, the static CMR specification is not adequate in quantifying the electrical noise susceptibility for optocouplers used in isolating high speed data transfer.

A serial data communication network’s noise performance is usually quantified as the number of bit errors per second or as a ratio of the number of bits transmitted in a specified time frame. This describes Bit Error Rate, BER. Test equipment that evaluates BER is called a Bit Error Rate Tester, BERT. When a BERT system is combined with a CMR tester, the active or dynamic noise rejection of an isolated interface can then be quantified. This type of CMR is thus defined as “**Dynamic CMR**”. Therefore, evaluating the common mode rejection while the optocoupler is switching at high speed represents a realistic approach to understand noise interference.

Test circuit functions were built to interface a commercial pseudo-random bit sequence (PRBS) generator and error detector with a pair of high speed optocouplers, FOD8001, connected in a loop-back configuration. With a 10MBaud PRBS serial data stream, no error was detected until the common mode voltage rose above 2.5kV with a dv/dt of 45kV/us. And increasing the data rate beyond 10Mbaud, the test was conducted at 20MBaud, and no error was detected at dv/dt of 25kV/us at common mode voltage of 1.5kV.

The test data for the dynamic CMR is comparable or better than the static CMR specifications found in the datasheet. These excellent noise rejection performances are results of the innovative circuit design and the patented coplanar assembly process.

Power Supply Noise Rejection

High levels of electrical noise can cause the optocoupler to register the incorrect logic state. The most commonly discussed noise signal is the common mode noise found between the input and output of the optocoupler. However, common mode noise is not the only path of noise into the input or output of the optocoupler. Due to the high gain and wide bandwidth of the transimpedance amplifier used for the photo detector circuits, power supply noise can cause the optocoupler to change state independent of the LED operation. Power supply noise is typically characterized as either random or periodic pulses with varying amplitudes and rates of rise and fall. The necessary tests have been conducted to understand the influence of the power supply noise and its effect of the proper operation of the FOD8001. The optocoupler under test offered power supply noise rejection in excess of 10% of the supply voltage for a frequency ranging from 100kHz to 35MHz, for logic high and logic low states.

Small Outline Package Dimensions

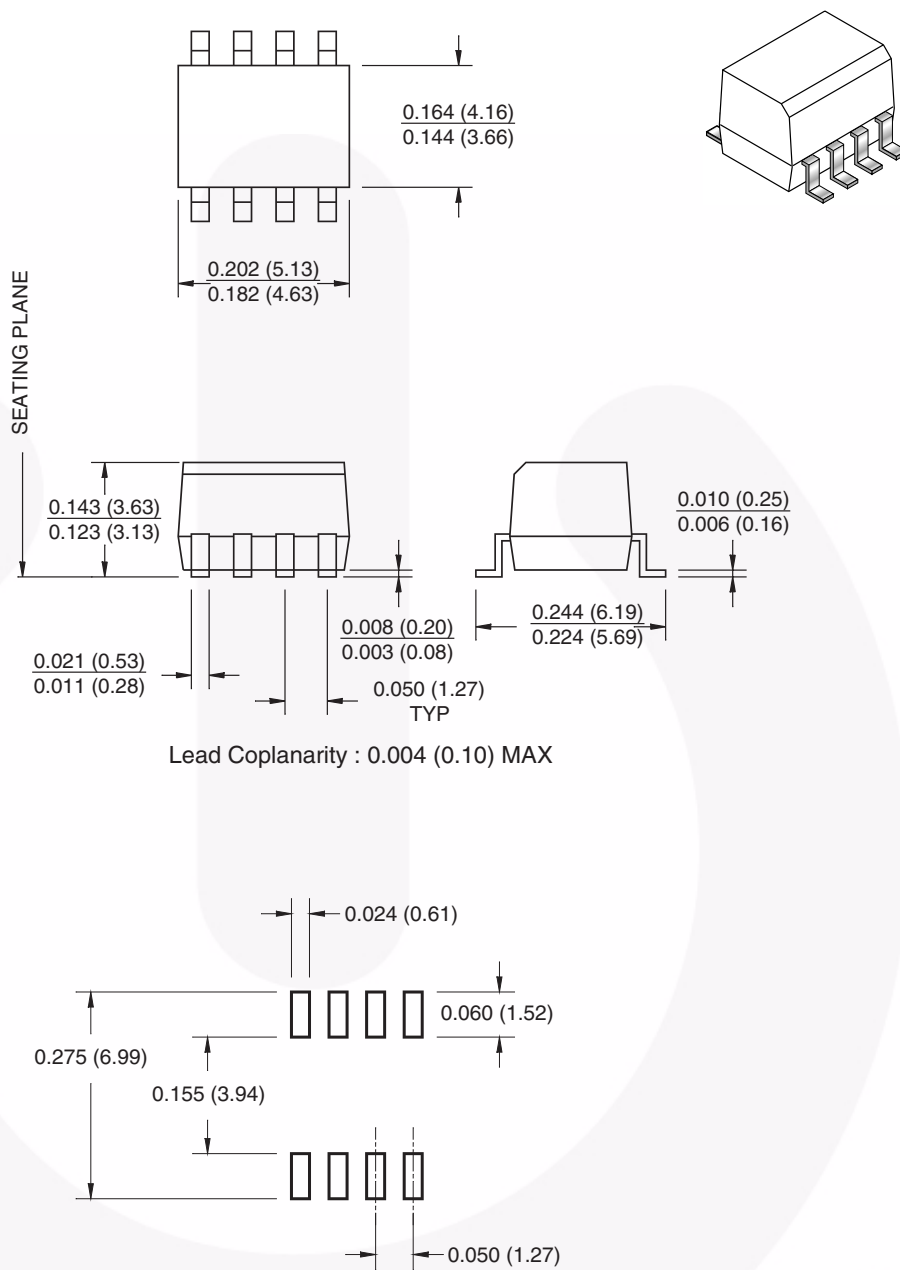

Note:

All dimensions are in millimeters.

Package drawings are provided as a service to customers considering Fairchild components. Drawings may change in any manner without notice. Please note the revision and/or date on the drawing and contact a Fairchild Semiconductor representative to verify or obtain the most recent revision. Package specifications do not expand the terms of Fairchild's worldwide terms and conditions, specifically the warranty therein, which covers Fairchild products.

Always visit Fairchild Semiconductor's online packaging area for the most recent package drawings:

<http://www.fairchildsemi.com/packaging/>

Carrier Tape Specification

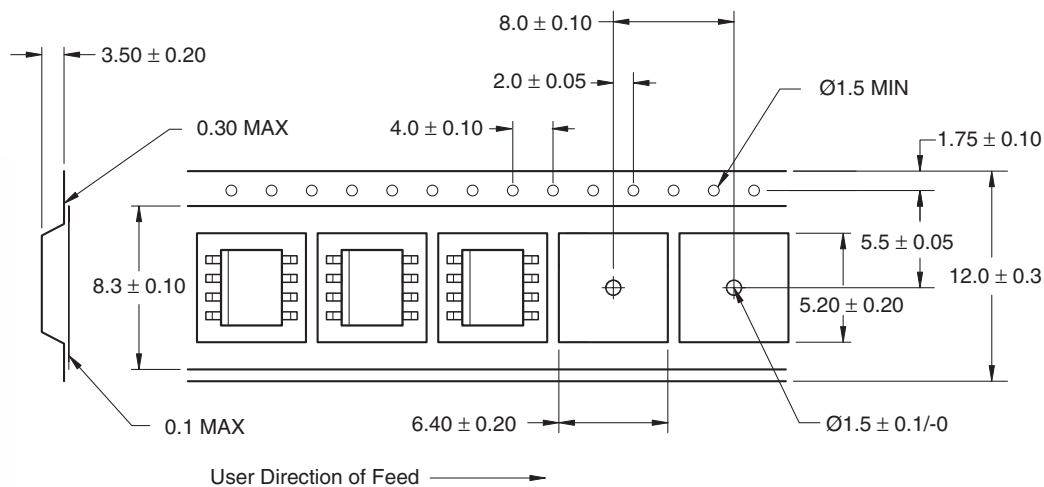

Note:
All dimensions are in millimeters.

Ordering Information

Option	Order Entry Identifier	Description
No Suffix	FOD8001	Small outline 8-pin, shipped in tubes (50 units per tube)
R2	FOD8001R2	Small outline 8-pin, tape and reel (2,500 units per reel)

All packages are lead free per JEDEC: J-STD-020B standard.

Marking Information

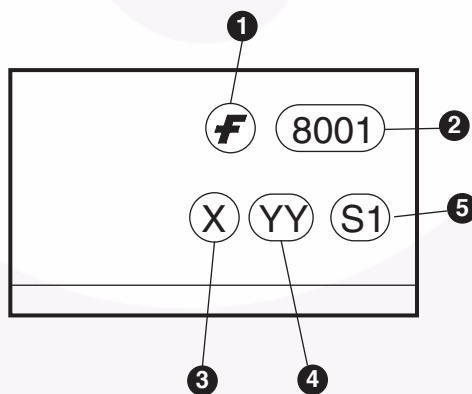

Definitions	
1	Fairchild logo
2	Device number
3	One digit year code, e.g., '8'
4	Two digit work week ranging from '01' to '53'
5	Assembly package code



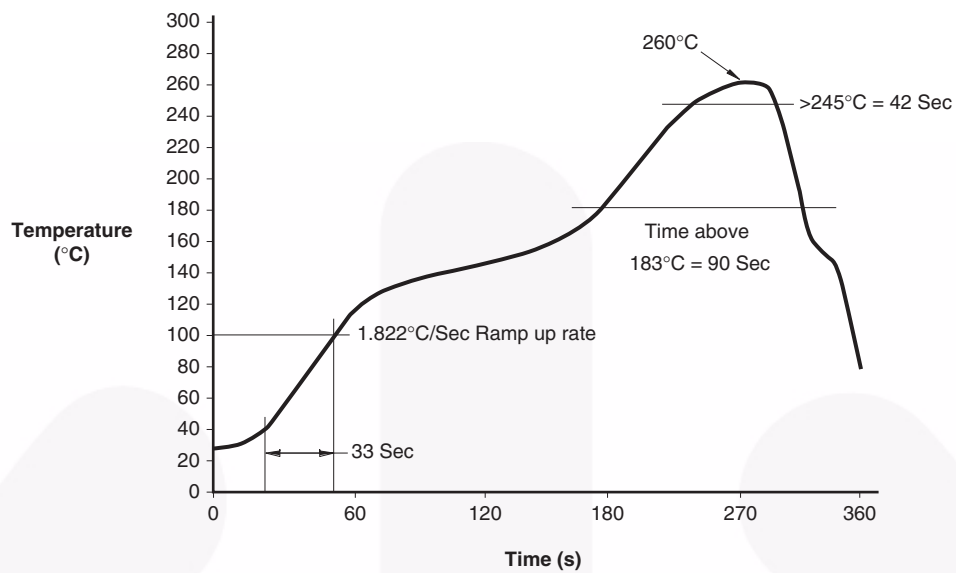

Reflow Profile





TRADEMARKS

The following includes registered and unregistered trademarks and service marks, owned by Fairchild Semiconductor and/or its global subsidiaries, and is not intended to be an exhaustive list of all such trademarks.

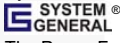
- | | | | |
|---|---|---|---|
| Build it Now™ | FRFET® | Programmable Active Droop™ | the power franchise |
| CorePLUS™ | Global Power Resource SM | QFET® | TinyBoost™ |
| CorePOWER™ | Green FPS™ | QS™ | TinyBuck™ |
| CROSSVOLT™ | Green FPS™ e-Series™ | Quiet Series™ | TinyLogic® |
| CTL™ | GTO™ | RapidConfigure™ | TINYOPTO™ |
| Current Transfer Logic™ | IntelliMAX™ |  ™ | TinyPower™ |
| EcoSPARK® | ISOPLANAR™ | Saving our world, 1mW/W/kW at a time™ | TinyPower™ |
| EfficientMax™ | MegaBuck™ | SmartMax™ | TinyWire™ |
| EZSWITCH™ * | MICROCOUPLER™ | SMART START™ | μSerDes™ |
|  ™ | MicroFET™ | SPM® |  ™ |
|  ™ | MicroPak™ | STEALTH™ | UHC® |
| Fairchild® | MillerDrive™ | SuperFET™ | Ultra FRFET™ |
| Fairchild Semiconductor® | MotionMax™ | SuperSOT™3 | UniFET™ |
| FACT Quiet Series™ | Motion-SPM™ | SuperSOT™L6 | Vcx™ |
| FACT® | OPTOLOGIC® | SuperSOT™L8 | VisualMax™ |
| FAST® | OPTOPLANAR® | SupreMOS™ | XS™ |
| FastvCore™ |  ™ | SyncFET™ | |
| FlashWriter® * | PDP SPM™ |  ™ | |
| FPS™ | Power-SPM™ | The Power Franchise® | |
| F-PFS™ | PowerTrench® | | |
| | PowerXS™ | | |

* EZSWITCH™ and FlashWriter® are trademarks of System General Corporation, used under license by Fairchild Semiconductor.

DISCLAIMER

FAIRCHILD SEMICONDUCTOR RESERVES THE RIGHT TO MAKE CHANGES WITHOUT FURTHER NOTICE TO ANY PRODUCTS HEREIN TO IMPROVE RELIABILITY, FUNCTION, OR DESIGN. FAIRCHILD DOES NOT ASSUME ANY LIABILITY ARISING OUT OF THE APPLICATION OR USE OF ANY PRODUCT OR CIRCUIT DESCRIBED HEREIN; NEITHER DOES IT CONVEY ANY LICENSE UNDER ITS PATENT RIGHTS, NOR THE RIGHTS OF OTHERS. THESE SPECIFICATIONS DO NOT EXPAND THE TERMS OF FAIRCHILD'S WORLDWIDE TERMS AND CONDITIONS, SPECIFICALLY THE WARRANTY THEREIN, WHICH COVERS THESE PRODUCTS.

LIFE SUPPORT POLICY

FAIRCHILD'S PRODUCTS ARE NOT AUTHORIZED FOR USE AS CRITICAL COMPONENTS IN LIFE SUPPORT DEVICES OR SYSTEMS WITHOUT THE EXPRESS WRITTEN APPROVAL OF FAIRCHILD SEMICONDUCTOR CORPORATION.

As used herein:

- Life support devices or systems are devices or systems which, (a) are intended for surgical implant into the body or (b) support or sustain life, and (c) whose failure to perform when properly used in accordance with instructions for use provided in the labeling, can be reasonably expected to result in a significant injury of the user.
- A critical component in any component of a life support, device, or system whose failure to perform can be reasonably expected to cause the failure of the life support device or system, or to affect its safety or effectiveness.

ANTI-COUNTERFEITING POLICY

Fairchild Semiconductor Corporation's Anti-Counterfeiting Policy. Fairchild's Anti-Counterfeiting Policy is also stated on our external website, www.fairchildsemi.com, under Sales Support.

Counterfeiting of semiconductor parts is a growing problem in the industry. All manufacturers of semiconductor products are experiencing counterfeiting of their parts. Customers who inadvertently purchase counterfeit parts experience many problems such as loss of brand reputation, substandard performance, failed applications, and increased cost of production and manufacturing delays. Fairchild is taking strong measures to protect ourselves and our customers from the proliferation of counterfeit parts. Fairchild strongly encourages customers to purchase Fairchild parts either directly from Fairchild or from Authorized Fairchild Distributors who are listed by country on our web page cited above. Products customers buy either from Fairchild directly or from Authorized Fairchild Distributors are genuine parts, have full traceability, meet Fairchild's quality standards for handling and storage and provide access to Fairchild's full range of up-to-date technical and product information. Fairchild and our Authorized Distributors will stand behind all warranties and will appropriately address any warranty issues that may arise. Fairchild will not provide any warranty coverage or other assistance for parts bought from Unauthorized Sources. Fairchild is committed to combat this global problem and encourage our customers to do their part in stopping this practice by buying direct or from authorized distributors.

PRODUCT STATUS DEFINITIONS

Definition of Terms

Datasheet Identification	Product Status	Definition
Advance Information	Formative / In Design	Datasheet contains the design specifications for product development. Specifications may change in any manner without notice.
Preliminary	First Production	Datasheet contains preliminary data; supplementary data will be published at a later date. Fairchild Semiconductor reserves the right to make changes at any time without notice to improve design.
No Identification Needed	Full Production	Datasheet contains final specifications. Fairchild Semiconductor reserves the right to make changes at any time without notice to improve the design.
Obsolete	Not In Production	Datasheet contains specifications on a product that is discontinued by Fairchild Semiconductor. The datasheet is for reference information only.

Rev. 137